

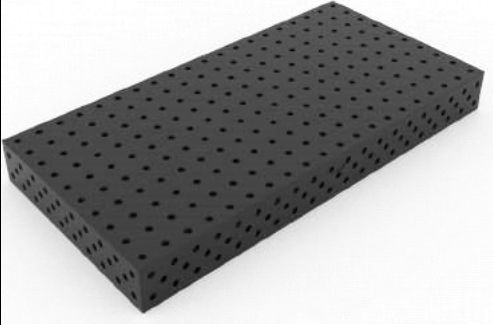

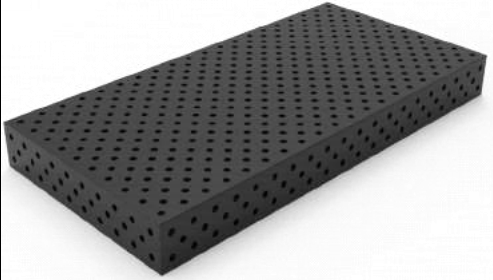







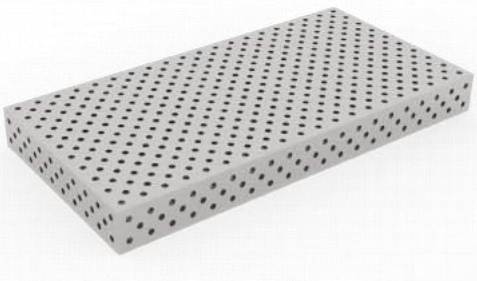



No	Description	Picture	Size(mm)	Number
1	<b>Steel With Plasma Nitriding</b>		1000x1000x200	TA281010N
2			1200x800x200	TA281208N
3			1200x1200x200	TA281212N
4			1500x1000x200	TA281510N
5			1500x1500x200	TA281515N
6			2000x1000x200	TA282010N
7			2000x1200x200	TA282012N
8			2000x2000x200	TA282020N
9			2400x1200x200	TA282412N
10			3000x1500x200	TA283015N
11			4000x2000x200	TA284020N
12	<b>Steel With Plasma Nitriding Diagonal Holes</b>		1000x1000x200	TA281010D
13			1200x800x200	TA281208D
14			1200x1200x200	TA281212D
15			1500x1000x200	TA281510D
16			1500x1500x200	TA281515D
17			2000x1000x200	TA282010D
18			2000x1200x200	TA282012D
19			2000x2000x200	TA282020D
20			2400x1200x200	TA282412D
21			3000x1500x200	TA283015D
22			4000x2000x200	TA284020D
23	<b>Cast Iron</b>		1500x1000x200	TA281510C
24			2000x1000x200	TA282010C
25			2400x1200x200	TA282412C
26			3000x1500x200	TA283015C

27	<b>Cast Iron Diagonal Holes</b>		1500x1000x200	TA281510CD
28			2000x1000x200	TA282010CD
29			2400x1200x200	TA282412CD
30			3000x1500x200	TA283015CD
31		 <b>Octagon</b>		600x600x100
32			800x800x200	TA2880
33			1000x1000x200	TA28100
34			1200x1200x200	TA28120
<b>Legs and Bracket</b>				
36	Standard leg		φ89x650	TU28650
37	Telescoping leg		φ89x550-900	TU28900











38	Heavy-duty wheel		φ89*650	TU28650.1
39	Hydraulic Lifting Type Supporting 		1000x1000	XJ1010
40			1200x1200	XJ1212
41			1500x1500	XJ1515
42			2000x1000	XJ2010
43				2400x1200
44				
45	Product	Picture	Size(mm)	Model
46	Spacer Angle U-shape 		500x200x200	UF280500
47			1000x200x200	UF281000
48			1500x200x200	UF281500
49			2000x200x200	UF282000
50			3000x200x200	UF283000
51			4000x200x200	UF284000
52	Clamping and Locating Angle		275x100x300(left)	ZC28300.1







53		275x100x300(right )	ZC28300.2
54		325x100x600(left)	ZC28600.1
55		325x100x600(right )	ZC28600.2

56		375x100x800(left)	ZC28800.1	
57		375x100x800(right )	ZC28800.2	
58	Corner Module		200x200x175	JX28001-1
59	Consoles		300x200x100	FL28300
60			500*200*100	FL28500
61	Universal Pivot and Tilt Angle		500x100x100	JD28500

62				
63	Product	Picture	Size(mm)	Model
64			175x50x175 Holes/Holes	DJ28175175
65			175x50x175 Slot/Slot	DJ28175175.1
66			175x50x175 Holes/Slot	DJ28175175.2
67			175x50x75	DJ2817575

68			75x50x75	DJ287575
69			200x50x175	DJ28200175
70			175x50x275	DJ28275175
71			100x50x25	PC28100
72			150x50x25	PC28150

73			225x50x25	PC28225
74			300x50x25	PC28300
75			500x100x25	PC28500
76			750x100x50	PC28750
77			1000x100x50	PC281000
78	Plane Angle Locator		250x150x5	JP28250
79	Flat Angle Bracket 		175x175x25	PM28175
80			500x375x25	PM28500
81	V-block Locations		$\varnothing 60 \times 135^\circ$	VX2860135
82			$\varnothing 80 \times 90^\circ$	VX288090
83			$\varnothing 120 \times 157^\circ$	VX28120157
84				

85	Product	Picture	Size(mm)	Model
86	screw clamp 180°		220X270	YJ28001
87	screw clamp 90°		270X100	YJ28002
88	screw clamp 45°		220x270	YJ28003
89	screw clamp 180° Plus		220x350	YJ28001.2
90	Vertical Toggle Clamp with Adapter		200x150x50	YJ28004
91	Horizontal toggle clamp with adapter		200x100x50	YJ28005

92	Eccentric Stop		φ 100x25mm(Height)	GP100
93	2-point Clamping Bridge		170x35x20	YT28006
94				
95	Product	Picture	Size(mm)	Model
96	Bolt		φ28 x 50mm	SX28001







97			φ28 x 75mm	SX28001.1
98	Countersunk Bolt		φ28x50mm	SX28002
99			φ28x75mm	SX28002.1
100	Magnetic Locking Bolt		φ28x25	CX2850
101	Positioning Bolt		φ28x50	DX2850
102	Connecting Bolt		φ28x50	LX2850
103	Bolts With Handle		φ28x50mm	SX28005
104				









105	Product	Picture	Size(mm)	Model
106	Adjustable Spacer		φ80x95mm (Max Height)	TG28001
107	Transport Ring		Max Bearing Force: 2T	QD28001
108	Accessory Cart		1100x1000x650m m	GJ28001









109	Ground Connector			JD28001
110	Spacer set		0.5-20mm	TZ28001
111	Hexagon Allen Wrench		150mm	BS28001
112	Nylon Brush		φ30x80mm	MS28001
113	Oil Stone			YS28001
114	Pump Spray Bottle			YF28001
115	Burner Holder			HQ28001







## 28 SYSTEM SET 1

						
180°Clamp	45°Clamp	V-Block	Fast Bolt	Stop	Stop	Square
burnished	burnished	burnished	burnished	Steel	Steel	Steel
YJ28001	YJ28003	VX28090	SX28001	PC28150	PC28225	DJ28175175.2
4 x	2 x	2 x	12 x	4 x	4 x	2 x

							
Square	D28 Transport Ring	Ground connector	Burner Holder	Eccentric Stop	Allen Wrench	Brush	Oilstone
Casting			burnished	brüniert			
280152	QD28001	JD28001	HQ28001	GP100	BS28001	MS28001	YS28001
2 x	1 x	1 x	1 x	1 x	1 x	1 x	1 x

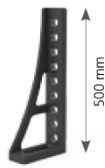

















## 28 SYSTEM SET 2

						
180°Clamp	45°Clamp	V-Block	Fast Bolt	Magnetic Bolt	Stop	Stop
burnished	burnished	burnished	burnished	Aluminium	Steel	Steel
YJ28001	YJ28003	VX28090	SX28001	MP2825	PC28150	PC28225
6 x	4 x	4 x	18 x	4 x	6 x	6 x



















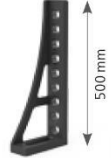

						
Square	Square	Square	D28 Transport Ring	Ground connector	Burner Holder	Eccentric Stop
Steel	Casting	Casting			burnished	brüniert
DJ28175175.2	280152	280162	QD28001	JD28001	HQ28001	GP100
4 x	2 x	2 x	1 x	1 x	1 x	1 x

		
Allen Wrench	Brush	Oilstone
BS28001	MS28001	YS28001
1 x	1 x	1 x

## 28 SYSTEM SET 3















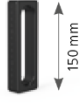





						
180°Clamp	45°Clamp	V-Block	Fast Bolt	Magnetic Bolt	Stop	Stop
burnished	burnished	burnished	burnished	Aluminium	Steel	Steel
YJ28001	YJ28003	VX28090	SX28001	MP2825	PC28150	PC28225
10 x	6 x	4 x	24 x	4 x	8 x	8 x
750 mm						
						
Square	Square	Square	Square	D28 Transport Ring	Ground connector	Burner Holder
Steel	Casting	Casting	Casting			burnished
DJ28175175.2	280152	280162	280166+67	QD28001	JD28001	HQ28001
6 x	2 x	2 x	1 x + 1 x	1 x	1 x	1 x
						
Eccentric Stop	Allen Wrench	Brush	Oilstone			
brüniert						
GP100	B528001	MS28001	YS28001			
1 x	1 x	1 x	1 x			

## 28 SYSTEM SET 4



















						
180°Clamp	45°Clamp	V-Block	Fast Bolt	Magnetic Bolt	Stop	Stop
burnished	burnished	burnished	burnished	Aluminium	Steel	Steel
YJ28001	YJ28003	VX28090	SX28001	MP2825	PC28150	PC28225
14 x	10 x	6 x	30 x	8 x	10 x	10 x
						
Stop	Square	Square	Square	Square	Tool Cart	
Steel	Steel	Casting	Casting	Casting		
PC28500	DJ28175175.2	280152	280162	280166+67	GJ28001	
4 x	8 x	2 x	2 x	1 x + 1 x	1 x	
						
Eccentric Stop	Allen Wrench	Brush	Oilstone	D28 Transport Ring	Ground connector	Burner Holder
brüniert						burnished
GP100	BS28001	MS28001	YS28001	QD28001	JD28001	HQ28001
1 x	1 x	1 x	1 x	1 x	1 x	1 x

## 28 SYSTEM





















## SET 5

						
180°Clamp	45°Clamp	V-Block	Fast Bolt	Magnetic Bolt	Stop	Stop
burnished	burnished	burnished	burnished	Aluminium	Steel	Steel
YJ28001	YJ28003	VX28090	SX28001	MP2825	PC28150	PC28225
<b>14 x</b>	<b>10 x</b>	<b>8 x</b>	<b>36 x</b>	<b>8 x</b>	<b>12 x</b>	<b>12 x</b>
						
Stop	Square	Square	Square	Square	Square	Tool Cart
Steel	Steel	Casting	Casting	Casting	Casting	
PC28500	DJ28175175.2	280152	280162	280166+67	ZC28800.1+2	GJ28001
<b>4 x</b>	<b>12 x</b>	<b>2 x</b>	<b>2 x</b>	<b>1 x + 1 x</b>	<b>1 x + 1 x</b>	<b>1 x</b>
						
Eccentric Stop	Allen Wrench	Brush	Oilstone	D28 Transport Ring	Ground connector	Burner Holder
brüniert						burnished
GP100	B528001	MS28001	YS28001	QD28001	JD28001	HQ28001
<b>1 x</b>	<b>1 x</b>	<b>1 x</b>	<b>1 x</b>	<b>1 x</b>	<b>1 x</b>	<b>1 x</b>

## SET A

					
180°Clamp 220*270mm YJ28001	90°Clamp 100*270mm YJ28002	145°Clamp 220*270mm YJ28003	Fast Bolt Ø28*50mm SX28001	Magnetic Bolt Ø28*25mm CX2825	V-Block Ø60*135° VX2860135
16x	8x	8x	24x	4x	4x
					
Stop 150*50*25mm PC28150	Stop 225*50*25mm PC28225	Square 175*175*50mm DJ28175175-3	Square 275*175*50mm DJ28275175	Square 275*100*300mm ZC28300.1+2	
10x	10x	10x	10x	1x+1x	
					
Square 325*100*600mm ZC28600.1+2	Transport Ring Max Bearing Force: 2T QD28001	Eccentric Stop Ø100*25mm GP100	Byrner holder Burnished HQ28001	Ground connector JD28001	
1x+1x	1x	1x	1x	1x	
					
Allen wrench BS28001	Brush MS28001	Oilstone Ø30*80mm YS28001			
1x	1x	1x			

## SET B

					
180°Clamp	90°Clamp	145°Clamp	Fast Bolt	Magnetic Bolt	V-Block
220*270mm	100*270mm	220*270mm	Ø28*50mm	Ø28*25mm	Ø60*135°
YJ28001	YJ28002	YJ28003	SX28001	CX2825	VX2860135
20×	10×	10×	36×	8×	6×
					
Stop	Stop	Stop	Square	Square	
150*50*25mm	225*50*25mm	500*100*25mm	175*175*50mm	275*175*50mm	
PC28150	PC28225	PC28500	DJ28175175-3	DJ28275175	
20×	20×	2×	15×	15×	
					
Square	Square	Transport Ring	Eccentric Stop	Byrner holder	
275*100*300mm	325*100*600mm	Max Bearing Force: 2T	Ø100*25mm	Burnished	
ZC28300.1+2	ZC28600.1+2	QD28001	GP100	HQ28001	
1×+1×	1×+1×	1×	1×	1×	
					
Ground connector	Allen wrench	Brush	Oilstone		
JD28001	BS28001	MS28001	YS28001		
1×	1×	1×	1×		

## SET C

					
180°Clamp	90°Clamp	145°Clamp	Fast Bolt	Magnetic Bolt	V-Block
220*270mm	100*270mm	220*270mm	Ø28*50mm	Ø28*25mm	Ø60*135°
YJ28001	YJ28002	YJ28003	SX28001	CX2825	VX2860135
30x	15x	15x	48x	10x	8x
					
Stop	Stop	Stop	Square	Square	
150*50*25mm	225*50*25mm	500*100*25mm	175*175*50mm	275*175*50mm	
PC28150	PC28225	PC28500	DJ28175175-3	DJ28275175	
30x	30x	4x	20x	20x	
					
Square	Square	Square	Transport Ring	Eccentric Stop	
275*100*300mm	325*100*600mm	375*100*800mm	Max Bearing Force: 2T	Ø100*25mm	
ZC28300.1+2	ZC28600.1+2	ZC28800.1+2	QD28001	GP100	
1x+1x	1x+1x	1x+1x	1x	1x	
					
Byrner holder	Ground connector	Allen wrench	Brush	Oilstone	Accessory Cart
Burnished			Ø30*80mm		110*1000*650mm
HQ28001	JD28001	BS28001	MS28001	YS28001	GJ28001
1x	1x	1x	1x	1x	1x